

## RM10G/RM10N

## HYBRID RECORDER

## OUTLINE

THE RM10G AND RM10N ARE HYBRID RECORDER ALLOWS DIGITAL PRINTOUT ON ANALOG TREND OR PEN TRACES ON 100 mm WIDE CHART PAPER. THE RM10G OFFERS 152 x 152 mm DIN SIZE PANEL AND THE RM10N REPLACES FORMER MODEL RE10 RECORDER.

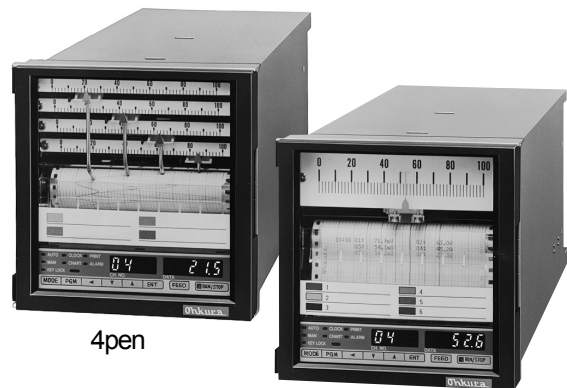

4pen

6 dot point

## FEATURES

- CONTACT FREE FEEDBACK POTENTIOMETER AND INPUT SELECTOR
- BOTH TREND & DATA LOGGING PRINTOUTS
- DIELECTRICS STRENGTH OF 2000V BETWEEN POWER INPUT AND GROUND
- ABUNDANCE OF PRINTOUT FUNCTION
- INDIVIDUAL SCALE PLATE
- INTRODUCTION OF DC BRUSHLESS MOTOR BY THIS, THE DURABLENESS, AND THE FASTER RESPONSE OF PEN RECORDER CAN BE ASSURED.
- WIDE RANGE OF POWER SUPPLY VOLTAGE
- OPTIONAL IC CARD

## SPECIFICATIONS

**Number of inputs:** 1,2,3,4 pen, 6 dot point.

**Type of input:**

**DC Voltage:** 4mVDC min., 20VDC max.

**Direct thermocouple:** K, T, J, E, B, S, R, G, C, N, PR40-20, PLII, U, L, Au-Fe

**RTD:** Pt100Ω, Pt50Ω, JPt100Ω, Cu10Ω (at 0°C), Cu10Ω (at 25Ω)

**Current:** 4 ~ 20mA

**Conductivity:** 100μS/m ~ 2000mS/m

**Recording width:** 100mm calibrated

**Recording accuracy:** ± 0.5% max.

**Open input protection (option):** Up scale with mV or TC input

**Chart speed:** 1, 2, 3 & 4 pen model; 1 ~ 3600mm/h  
6 point model; 1 ~ 1800mm/h

**Chart paper:** Fold chart standard, 12m long, 114mm width

**Data print color:** Purple (Red on alarm: dot type)

**Dot print interval:** 5 sec. per channel.

**Input sampling:** 120 msec. in pen model, 5 sec. per channel in dot point model.

**Cartridge pen:** Disposable felt pen

**Print head:** Pen models; Wire dot 1 color ribbon cartridge, Dot point models; 6 color ribbon cartridge

**Alarm:** 6 Set points per channel

**Alarm output (option):** 2 relays drive per setting. Form-C 250VAC 3A/125VDC 0.5A/30VDC 3A max., Hysteresis 0.5 ± 0.2%, Setting accuracy ± 0.5%

**Input impedance:** 10MΩ min. In mV/TC input. 200kΩ min. In mV/TC Input with open input protection, 1MΩ min. In Volt Input and 100Ω min. In mA Input

**Source impedance:** 10kΩ max. in mV/TC input, 200Ω max. in mV/TC Input with open input protection, 1kΩ max. In Volt input and 10Ω max. per wire in RTD input.

**CMRR:** 140dB min. in 50/60 ± 0.5Hz

**NMRR:** 60dB min. in 50/60 ± 0.5Hz

**Isolation resistance:** Input/ground 500VDC, 20MΩ min.

**Dielectric strength:** Power supply voltage/ ground 2000VAC, 1 minute duration. input/ground 500VAC, 1 minute duration

**Power supply voltage:** 85 ~ 264VAC, 45 ~ 65Hz ± 5%

**Allowable instant power failure:** 50ms max.

**Power consumption:** 70VA max.

**Vibration resistance:** 1m/s<sup>2</sup> max., 10 ~ 60Hz

**Shock resistance:** 2m/s<sup>2</sup> max.

**Operating conditions:** -5 ~ 50°C. 35 ~ 85%RH

**Dimensions:** RM10G; 144(w) x 144(h) x 430(d) mm

RM10N; 150(w) x 168(h) x 340(d) mm

RM10G(C); 144(w) x 144(h) x 430(d) mm

RM10G(D); 167(w) x 178(h) x 450(d) mm

RM10G(E); 150(w) x 150(h) x 430(d) mm

RM10G(G); 140(w) x 170(h) x 570(d) mm

RM10N(F); 150(w) x 168(h) x 390(d) mm

**Case structure:** Dust-proof

**Mounting:** Panel-mount

TYPE G,N; Allowable backward inclination : 30°

TYPE G(C), G(D), G(E), G(G), N(F);

Allowable backward inclination : 20°

**Material:** Case — Steel plate

Door frame — TYPE G ; Steel plate

TYPE N ; Aluminum die casting

Door—TYPE G,G (C); PC resin

TYPE G(D),G(E),G(G); Acryl

TYPE N,N(F); Aluminum die casting

**Color:** Case — Metallic silver

Door frame — Black(Standard)

**Weight:**

**G,N type** 5.0 kg max. (1 pen model);  
5.5kg max. (2 pen model);  
5.5 kg max. (3 pen model);  
6.0 kg max. (4 pen model);

**G(C) type, G(E) type, N(F) type**  
7.0 kg max. (1 pen model);  
7.5kg max. (2 pen model);  
7.5 kg max. (3 pen model);  
8.0 kg max. (4 pen model);

**G(D) type** 7.5 kg max. (1 pen model);  
8.0kg max. (2 pen model);  
8.0 kg max. (3 pen model);  
8.5 kg max. (4 pen model);

**G(G) type** 8.5 kg max. (1 pen model);  
9.0 kg max. (2 pen model);  
9.0 kg max. (3 pen model);  
10.0 kg max. (4 pen model);

**Mounting:** Panel mount**Material:** Aluminum die cast (Front bezel);  
Steel plate (Case)**Color:** Metallic silver (Case); Black (Door)**MAXIMUM RANGE & ACCURACY**

The Junction compensation accuracy is not added to digital readout accuracy and recording accuracy. The junction compensation accuracy is based on operating conditions: 23 ± 2°C temperature; 55 ± 10%RH humidity; 85 ~ 264VAC power source; 30 minutes min. warm-up time; no effect of vibration resistance and shock resistance.

Limit of compensation error: ± 1°C at R,S,B,PR40-20  
± 0.5°C at K,E,J,T,G,C,N

**Resolution:**

Range	Code	Max. Resolution
000 & 001		10uV
002		100uV
003,004,006,007		1mV
005		10mV
008		0.01mA
010-047, 049-058		0.1°C
048		0.1K

Digital readout accuracy: ± (0.2% + 1digit)

Recording accuracy: ± 0.5%

**NOTE:**

(\*1): Extension scaling up to 3 times among each ranges: ± (0.3% + 1digit)

(\*2): Ranges under a span of 0 ~400°C, can not guarantee accuracy

(\*3): Ranges of 0 ~ 300°C: ± 2%, 300 ~ 800°C: ± 1%

(\*4): Ranges of 0 ~ 200°C: ± 0.3% + 1digit

(\*5): ± (0.5% + 1digit)

(\*6): ± (0.8% + 1digit)

(\*2 ~ \*6):

Recording accuracy = digital readout accuracy ± 0.3%

**RANGE TABLE**

GROUP	INPUT	CODE	RANGE(*1)
Volt	mV	000	- 10.0 ~ +10.0mV
	mV	001	- 50.0 ~ +50.0mV
	mV	002	- 200.0 ~ +200.0mV
	V	003	- 1.0 ~ +1.0V
	V	004	- 5.0 ~ +5.0V
	V	005	- 20.0 ~ +20.0V
	V	006	0.0 ~ +5.0V
Current	V	007	+1.0 ~ +5.0V
	mA	008	4.0 ~ 20.0mA
TC	R	010	0.0 ~ 1450.0°C
	R	011	0.0 ~ 1760.0°C
	S	012	0.0 ~ 1760.0°C
	B	013	0.0 ~ 1830.0°C (*2)
	K	014	0.0 ~ 100.0°C
	K	015	0.0 ~ 700.0°C
	K	016	0.0 ~ 900.0°C
	K	017	- 200.0 ~ 100.0°C
	K	018	- 200.0 ~ 400.0°C
	K	019	- 200.0 ~ 650.0°C
	K	020	- 200.0 ~ 1370.0°C
	K	021	0.0 ~ 1000.0°C
	E	022	0.0 ~ 150.0°C
	E	023	0.0 ~ 400.0°C
	E	024	- 200.0 ~ 500.0°C
	E	025	- 200.0 ~ 600.0°C
	E	026	- 200.0 ~ 900.0°C
	E	027	- 200.0 ~ 250.0°C
	E	028	- 200.0 ~ 400.0°C
	E	029	- 200.0 ~ 700.0°C
	J	030	0.0 ~ 150.0°C
	J	031	0.0 ~ 500.0°C
	J	032	- 200.0 ~ 650.0°C
	J	033	- 200.0 ~ 300.0°C
	J	034	- 200.0 ~ 500.0°C
	J	035	- 200.0 ~ 900.0°C
	J	036	- 200.0 ~ 750.0°C
	T	037	0.0 ~ 150.0°C
	T	038	0.0 ~ 400.0°C
	T	039	- 200.0 ~ 350.0°C
	T	040	- 200.0 ~ 400.0°C
	G	041	0.0 ~ 2320.0°C
	C	042	0.0 ~ 2320.0°C
	N	043	0.0 ~ 900.0°C
N	044	0.0 ~ 1260.0°C	
PR40-20	045	0.0 ~ 1880.0°C (*3)	
U	046	- 200.0 ~ 400.0°C (*4)	
L	047	- 200.0 ~ 900.0°C (*4)	
Au-Fe	048	0.0 ~ 300.0°C (*5)	
RTD	JPt100	049	- 50.0 ~ 100.0°C
	JPt100	050	- 200.0 ~ 600.0°C
	Pt100	051	- 50.0 ~ 100.0°C
	Pt100	052	- 200.0 ~ 600.0°C
	JPt150	053	- 50.0 ~ 100.0°C
	JPt150	054	- 100.0 ~ 250.0°C
	JPt150	055	- 200.0 ~ 550.0°C
	Cu10Ω at25°C	056	- 50.0 ~ 200.0°C (*6)
	Cu10Ω at 0°C	057	- 50.0 ~ 200.0°C (*6)
TC	PLII	058	0.0 ~ 1360.0°C

## CONDUCTIVITY RECORDER

**Sensor:** Thermistor (2.5kΩ at 25°C, 400Ω at 25°C), Pt1000Ω at 0°C

**Solution temperature compensation:** Auto temp. compensator provided temp. Sensor by Thermistor for 5 ~ 45°C, Pt1000Ω for 0 ~ 100°C

Note 1: To be specified from 2.5

Note 2: Unavailable for purity water

**Recording accuracy:** ± 0.5% at 25°C

**Temperature characteristics:** ± 0.3% /10°C

**Isolation resistance:** Input/ground 200VDC, 20MΩ min.,

Other terminal than Input/ground 500VDC, 20MΩ min.

**Dielectric Strength:** Input/ground 200VAC, 1 minute duration, power Input/ground 2000VAC. 1 minute duration

**Common mode reduction ratio:** 100dB min(50/60 ± 0.5Hz)

## RANGE AND MAX. CABLE LENGTH

Length described below is based under use of our exclusive 3-cored or 5-cored cable.

Model: 3-cored cable: IPS0245A1500

5-cored cable; WPSN040A000001A

RANGE CODE	CELL CONSTANT	RANGE	MAX. CABLE LENGTH(m)
00	1(m <sup>-1</sup> )	0 ~ 100.0μS/m	50
01		0 ~ 200.0μS/m	90
02		0 ~ 500.0μS/m	90
03		0 ~ 1000μS/m	90
04	10(m <sup>-1</sup> )	0 ~ 1.000mS/m	50
05		0 ~ 2.000mS/m	90
06		0 ~ 5.000mS/m	90
07		0 ~ 10.00mS/m	90
08	100(m <sup>-1</sup> )	0 ~ 10.00mS/m	50
09		0 ~ 20.00mS/m	90
10		0 ~ 50.00mS/m	90
11		0 ~ 100.0mS/m	90
12		0 ~ 200.0mS/m	25
13	1000(m <sup>-1</sup> )	0 ~ 100.0mS/m	50
14		0 ~ 200.0mS/m	90
15		0 ~ 500.0mS/m	90
16		0 ~ 1000.0mS/m	90
17		0 ~ 2000.0mS/m	25

## STANDARD FUNCTIONS

FUNCTION	DESCRIPTION
Analog indication	Process variable is indicated on a scale plate.
Recording	Pen tracing (pen models), Printing with 5 marking by 6 color ribbon cartridge (dot point models).
Engineering unit indication	Engineering unit is indicated on the scale plate.
Digital display	Indicates channel no., process variable, date, chart speed, alarm set point in the display 1 & 2.
Scaling	Indicates and prints process variable with set point.
Logging print	Prints each channel's process variable, engineering unit on the chart paper. Printing mode is selected from analog recording, end mode for analog recording.
Date print	Prints year and date at a programmed time.
Time print	Prints time at a Programmed interval.
List print	Prints type of input, range, engineering unit. alarm set point, date. time, chart speed. scaling and logging print status on the chart paper.
Skip	Abandon dot print of inputs as required by dot point models.
Programming	Chart speed, alarm set point. logging print interval, skip, date and time can be programmed.
Memory backup	Back-up for clock by lithium batteries for 10 years or 5 years in unused and for program by non-volatile memory.
Key lock	If you don't use key for more than 5 minutes in a user mode, the key would be locked automatically.
Alarm	6 set points alarm per channel.
Chart speed	2 chart speeds can be programmed.
Time indicator	Indicates year, month, day, hour, minute. Adjust for leap year automatically
Self diagnostics	Indicates "ERROR", and outputs when CPU, printer. ADC are faulty.

## OPTION 2

CODE	FUNCTION	DESCRIPTION
A01	Open input protection	Sets Indicator at over 100% or 0% per Inputs when input becomes open for TC or $\pm 50\text{mV}$ max. Input.
A02	Zone recording	Recording on the Chart track ranged per Inputs.
A03	Expanded/reduced recording	Partial compression and enlargement in the same range can be done.
A04	Pen gap rectifying	Keep process time on pen tracks.
A05	Scale print	The scale values of zero point and span point of each channel are printed.
A06	Alarm on print	When an alarm arises, alarm-on time, alarm-on channel, alarm setting number, and alarm mode are printed in purple color.
A07	Alarm recovery on print	When an alarm is recovered, the time of recovery, the recovered channel, alarm setting number, and alarm mode are printed in purple color.
A08	Damping	Execute the first-order lag recording of the measured value through the digital filter.
A09	Range change	Change ranges with DI, 2 ranges max.
A10	Integration sum	Indicates and prints sum among channels.
A11	Integration balance	Indicates and prints balance among channels.
A12	Average among channels	Indicates and prints average among channels.
E01	Temperature balance	The actual temperature after subtracting the reference temperature of reference channel is designated and recorded.
E02	New alarm	New alarm channel is output in one-shot relay.
E04	Digital display ON/OFF	To turn off the designated value in the display through Auto Mode.
E05	Adjustment of print gap	To adjust a gap on the time axis between 1-pen and print.
E06	Max., min. and average value on print	Prints max., min. and average per inputs in logging print.
E07	Hysteresis width	Hysteresis width can be set. (Standard : 0.5% FS)
D02	DE connection	To execute the compensating temperature, taking in, the inside temperature of outside compensating box by thermocouple input of the set channel.
D03	DH connection	To execute the compensating temperature, taking in, the inside temperature of outside compensating box by the voltage wire (copper wire) of the set channel.

**NOTE:** Recording accuracy may change in case optional Zone Recording or Expanded/Reduced Recording is installed.

## DI REMOTE OPTIONS

CODE	FUNCTION	DESCRIPTION
B01	Chart start stop	Close: starts Open: stops
B02	Change chart speed	Close: 1st Open: 2nd
B03	Aux. chart drive	Chart feeding for external chart drive source
B04	Change chart drive source	Close: Internal Open: External
B05 B06 B07 B08 B09	Comment print 1 Comment print 2 Comment print 3 Comment print 4 Comment print 5	Prints up to 16 characters per verse.
B10	Remote logging print	Close: starts to print
B11	Remote date print	Close: starts to print
B12 B13 B14 B15	Range change 1 Range change 2 Range change 3 Range change 4	Close: changes range
B16	Integration input	Integrates in proportion to contact closing times
B17	Integration reset	Resets Integrated value
B18	New alarm reset	Close: executes to reset New Alarm

## OTHER OPTIONS

CODE	DESCRIPTION
C04	Clean chart
D04	Conductivity input
E03	Lamp hold/reset
E08	Manual chart speed change

**ALARM BOARD:** 4 relays.

## COMMUNICATION INTERFACE

FUNCTION	DESCRIPTION
INTERFACE	RS-232C
	RS-422A
	ARCNET

## IC MEMORY CARD

CODE	DESCRIPTION
F01	64K byte
F02	128K byte
F03	256K byte
F04	512K byte
F05	1M byte
F06	2M byte

- 1: Load and save available for programmed data.
- 2: Memory available for measured data.
- 3: Printing available for day and month report.
- 4: Back-up available for integration in instant Power failure.

# DIMENSIONS

(Unit = mm)

## RM10G TYPE

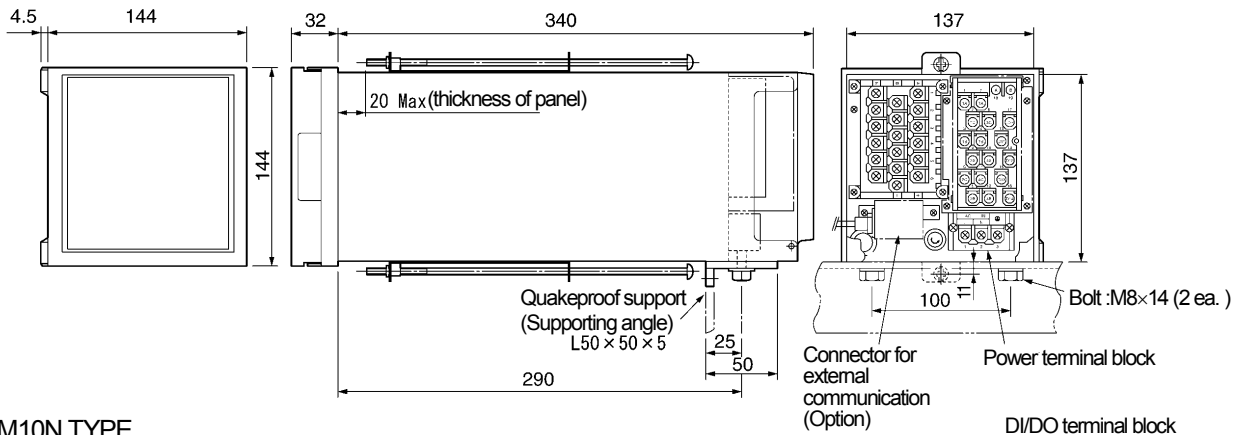

## RM10N TYPE

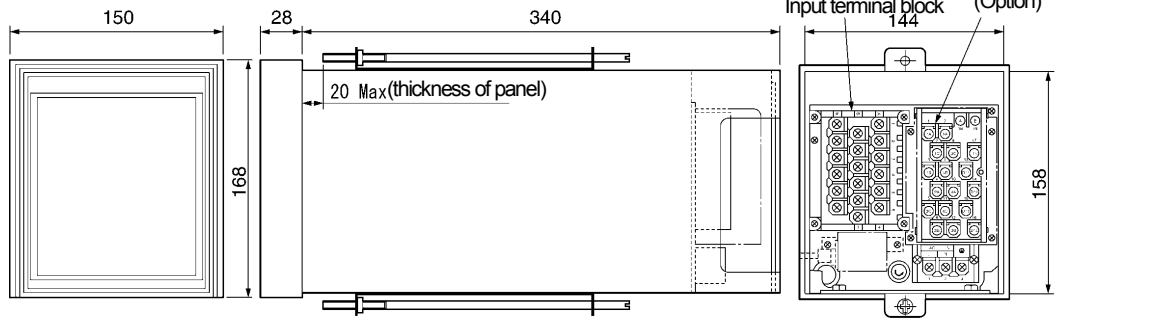

## RM10G(C) TYPE

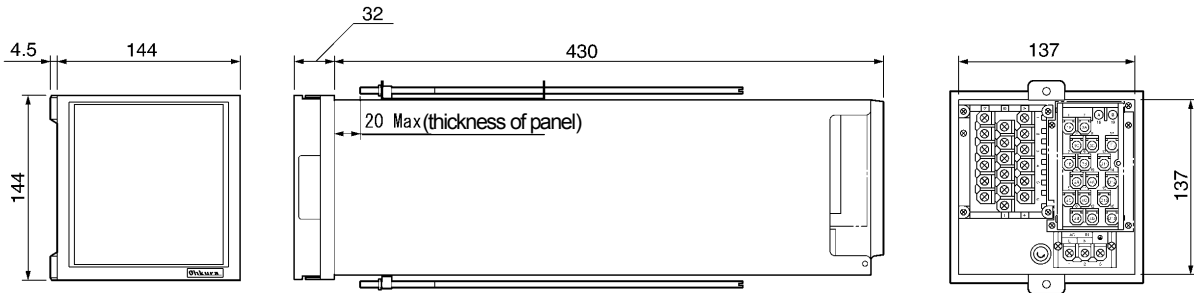

## RM10G(D) TYPE

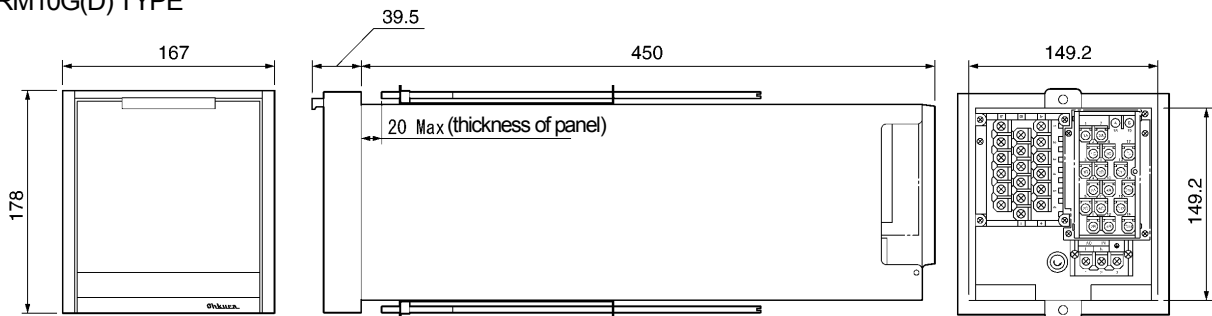

## RM10G(E) TYPE

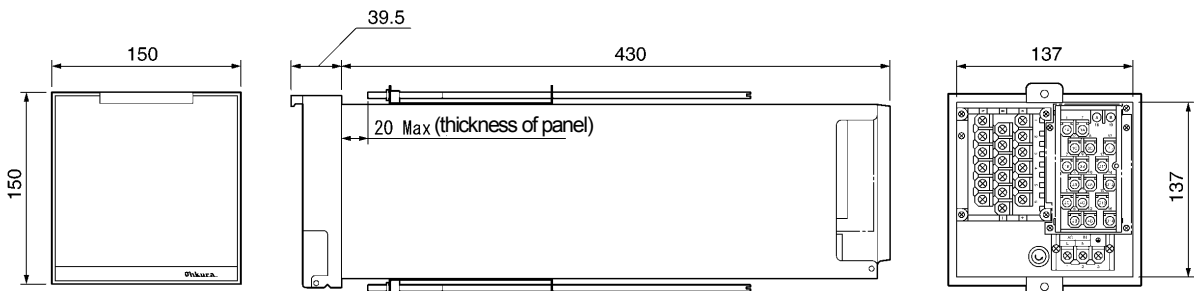

### RM10C(G) TYPE

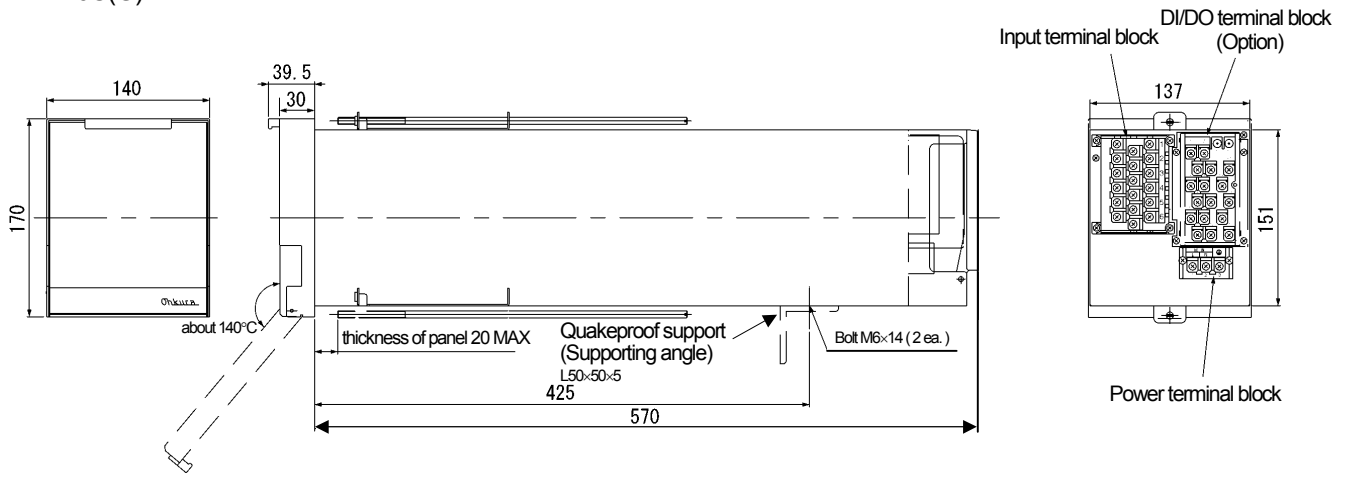

### RM10N(F) TYPE

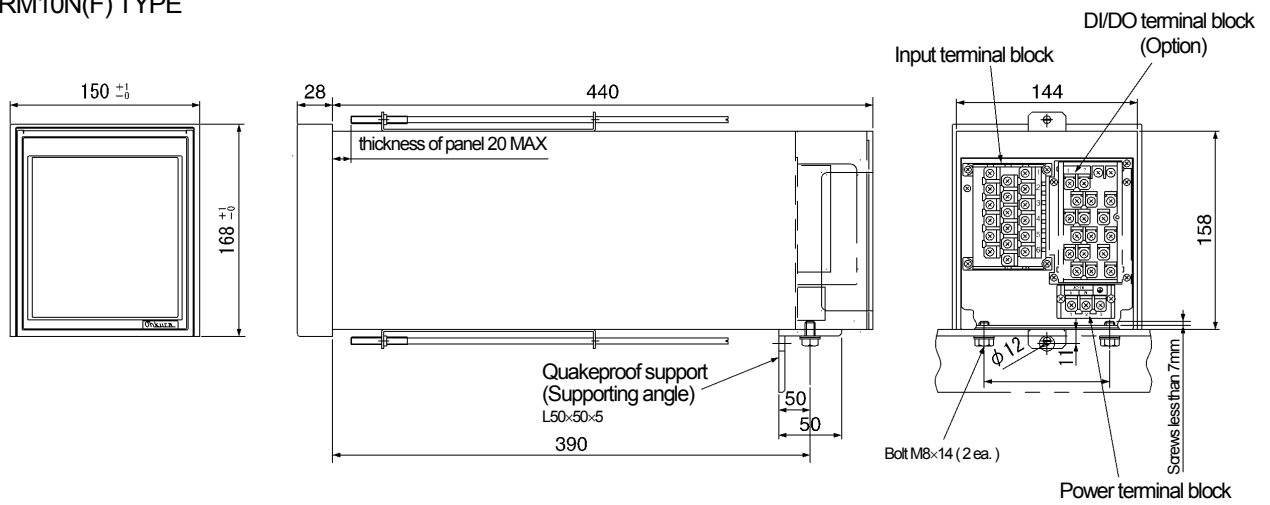

# PANEL CUTOUT

## RM10G, G(C) TYPE

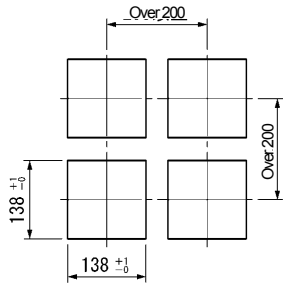

## RM10N, N(F) TYPE

In case of in stalling  
single unit :

In case of in stalling  
'N' numbers of unit :

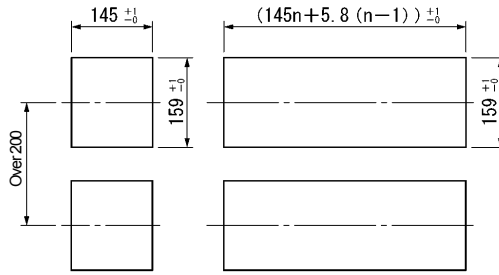

## RM10G, (D) TYPE

In case of in stalling  
single unit :

In case of in stalling  
'N' numbers of unit :

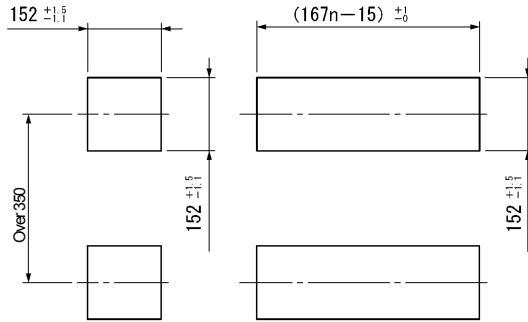

## RM10G, (E) TYPE

In case of in stalling  
single unit :

In case of in stalling  
'N' numbers of unit :

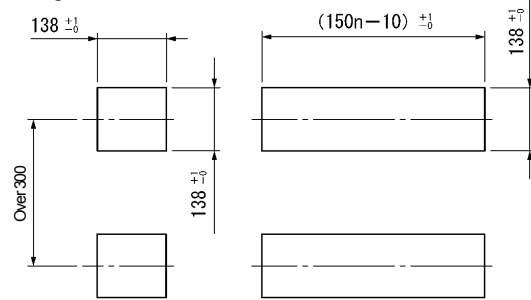

## RM10G, (G) TYPE

In case of in stalling  
single unit :

In case of in stalling  
'N' numbers of unit :

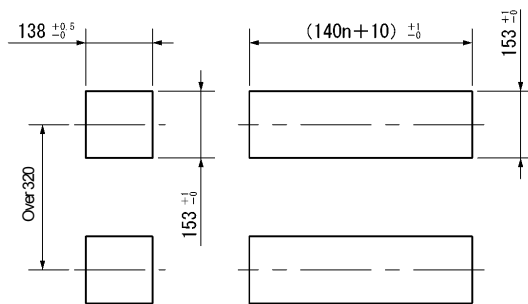

# TERMINAL ARRANGEMENT

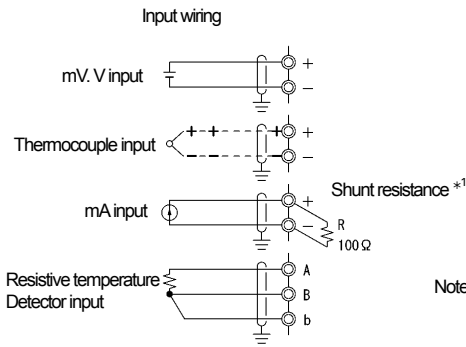
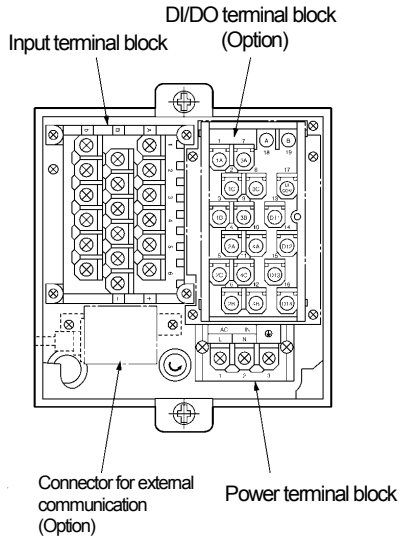

Input signal terminal details

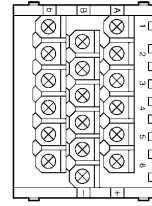

Note: Shunt resistance is set on the terminal block (except the built-in shunt resistance specification).

DI/DO terminal details

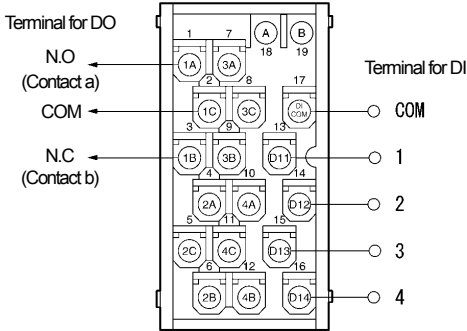

Electric conductivity recorder 3 - cored input

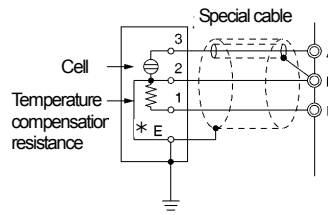

Electric conductivity recorder 5 - cored input

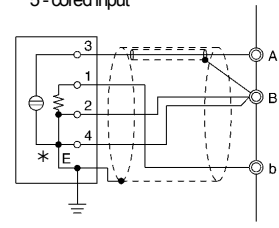

\* Connection with CI□□ type cell

Power wiring

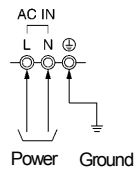

Power terminal details

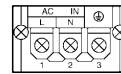



## MODEL CODE NUMBER

MODEL	BASE INSTRUMENT	
RM1001	1 pen recorder	
RM1002	2 pen recorder	
RM1003	3 pen recorder	
RM1004	4 pen recorder	
RM1006	6 point recorder	
	CODE	STRUCTURE
	G	Standard
	N	Equivalent panel cut size of the old model RE10
	CODE	COMMUNICATION INTERFACE
	0	None
	1	RS-232C
	2	RS-422A
	9	Special
	CODE	DI/DO
	0	None
	1	DI/DO
	2	DI/DO + ARC
	CODE	IC MEMORY CARD
	0	None
	1	Provided
	CODE	FRONT BEZEL COLOR
	1	N1.5 (Standard)
	2	7.5BG4/1.5
	3	N4
	4	N7
	5	7.5BG6/1.5
	9	Special
	CODE	QUAKE RESISTING SPEC
	A	
	B	
	C	
	D	
	E	
	F	
	G	
	CODE	SOFTWARE OPTION
	0	None
	1	Provided (Fill "1", if any option for code from A01 to F06 is Installed)
	CODE	OPTION
	0	None
	C	Conductivity recorder
	X	Custom hardware (Consult factory)
	Y	Custom software (Consult factory)
	Z	Custom hardware + software (Consult factory)

Note 1: Unavailable on 4 pen recorder.

Note 2: Available on multipoint recorder which input type other than T/C, Conductivity.

Note 3: To be added price of IC memory card for applicable capacity from code F01 to F06.

Note 4: Conductivity recorder can be specified on 6, input mixture unavailable.

## STANDARD ACCESSORIES

DESCRIPTION	MODEL	MODEL / NUMBERS					NOTE
		1PEN	2PEN	3PEN	4PEN	DOT POINT	
Box	H4H10711	1	1	1	1	1	
Lubricating oil	H4A12290	1	1	1	1	1	
Fuse	WPSJ011D000001A	1	1	1	1	1	
Chart paper	HZCGA0105AF001	1	1	1	1	1	50 division
Cartridge pen No.1	HPSR001K0001	1	1	1	1		Red
Cartridge pen No.2	HPSR001K0002		1	1	1		Blue
	HPSR001K0005		1	1	1		Green
Cartridge pen No.3	HPSR001K0003			1	1		Green
	HPSR001K0006			1	1		Blue
Cartridge pen No.4	HPSR001K0004				1		Purple
	HPSR001K0011				1		Brown
Ribbon cartridge	HPSR001H0002	1	1	1	1		Purple
Ribbon cartridge	HPSR001H0004					1	6 color
L. wrench	HPSAA003A001					1	for M3 screw
	H4P17841	2	2	2	2		G, G(C), G(E) G(G) type
	H4P15529	2	2	2	2		N, N(F) type
Screw	H4S10218						G type
	H4S0846802	2	2	2	2	2	N, N(F) type
	H4S0846801						G(C), G(E), G(G) type
Mounting bracket	H4A1226301	2	2	2	2		
Instruction manual	HXPRMN10mnG001	1	1	1	1		
	HXPRMN10mnG002					1	
	HXPRMN10mnG012	1	1	1	1		G(C) type (pen)
	HXPRMN10mnG015					1	G(C) type (dot point)
	HXPRMN10mnG013	1	1	1	1		G(D) type
	HXPRMN10mnG014	1	1	1	1		G(E) type
	HXPRMN10mnG016	1	1	1	1		N(F) type (pen)
	HXPRMN10mnG017					1	N(F) type (dot point)
	HXPRMN10mnG018	1	1	1	1		G(G) type
Engineering data manual	HXPRMN10mnG003	1	1	1	1		
	HXPRMN10mnG004					1	

## CAUTION

Do not install this device before consulting instruction manual

Specifications are subject to change without notice.

For further information, a quotation or a demonstration please contact to:

**Ohkura**

OHKURA ELECTRIC CO., LTD.

Head Office / Factory

Saitama, JAPAN

Sales Offices

Tokyo, Osaka, Nagoya, Kyushu, Tohoku

URL

<http://www.ohkura.co.jp/>

e-mail (in English)

[intsales@ohkura.co.jp](mailto:intsales@ohkura.co.jp)